

Passat - Standard Equipment, only for cars with blue illuminated instrument cluster

from September 1997

Deviate relay location and fuseplacements as well as the locations of multiple connectors see section "component locations".

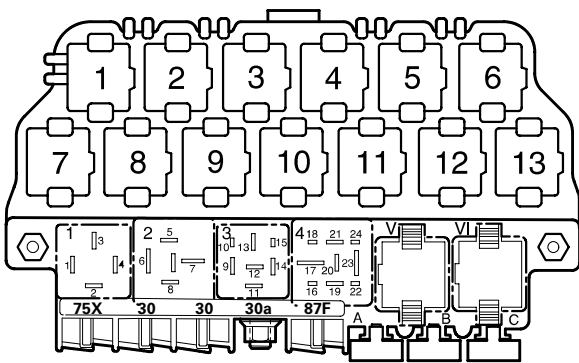

97-20676

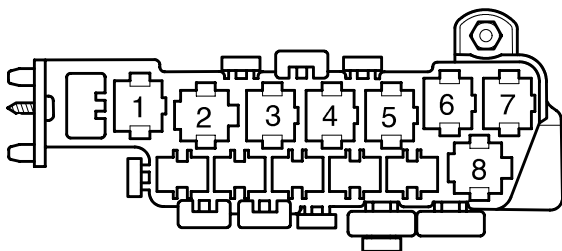

97-20515

Fuse colors

- 30 A - green
- 25 A - white
- 20 A - yellow
- 15 A - blue
- 10 A - red
- 7,5 A - brown
- 5 A - beige

Relay location on the thirteenfold auxiliary relay panel, above relay panel:

- 7** Fog Light Relay (381)
- 8** Daytime Running Lights Change-over Relay (173)
- 12** Starting Interlock Relay (alarm system) (186)
- 13** Starting Interlock Relay (clutch position) (204)

Relay panel:

- 1** Dual Horn Relay (204)
- 2** Load Reduction Relay (213)
- V** Wipper/Washer Intermittent Relay (377)
- VI** Wipper/Washer Intermittent Relay (377)

Relay location on the eightfold auxiliary relay panel, behind relay panel:

Note: Number in parentheses indicates production control number stamped on relay housing.

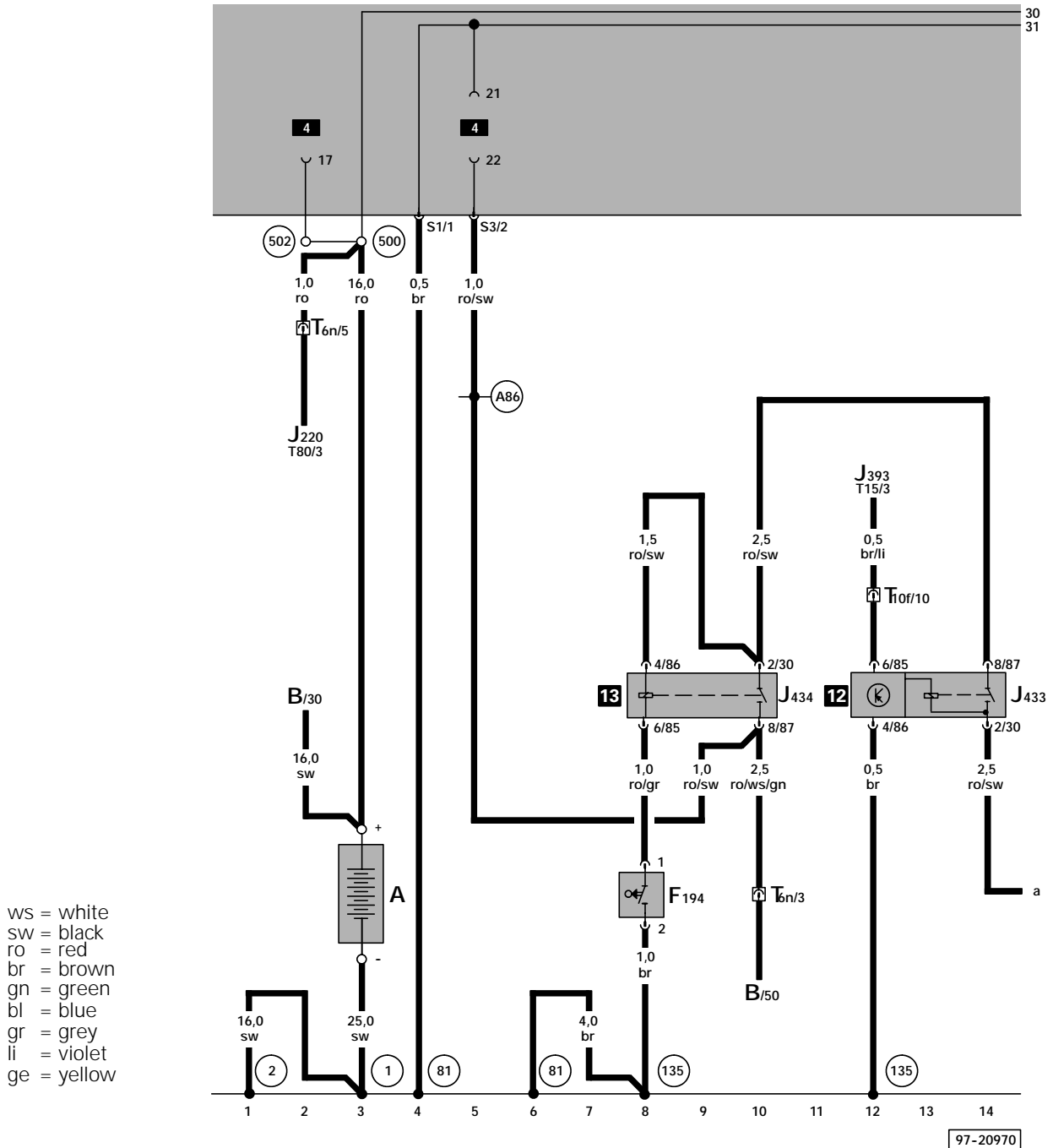

ws = white
 sw = black
 ro = red
 br = brown
 gn = green
 bl = blue
 gr = grey
 li = violet
 ge = yellow

- A - Battery
- B - Starter
- F194 - Clutch Pedal Position (CPP) Switch
- J220 - Motronic Engine Control Module (ECM)
- J393 - Central control module for comfort system
- J433 - Starting Interlock Relay (alarm system), on auxiliary relay panel, above relay panel, production control number (186)
- J434 - Starting Interlock Relay (clutch position), on auxiliary relay panel, above relay panel, production control number (204)
- T6n - 6-Pin Connector, red, on protective housing for control module, in engine compartment, left
- T10f - 10-Pin Connector, blue, connector station A-pillar, left
- T15 - 15-Pin Connector, on central control module for comfort system

- T80 - Connector, 80 point, on Engine Control Module (ECM)
- (1) - Ground strap, battery to body
- (2) - Ground strap, transmission to body
- (81) - Ground connection -1-, in instrument panel wiring harness
- (135) - Ground connection -2-, in instrument panel wiring harness
- (500) - Screw connection -1- (30), on relay panel
- (502) - Screw connection (30a), on relay panel
- (A86) - Connection (50a) in instrument panel wiring harness

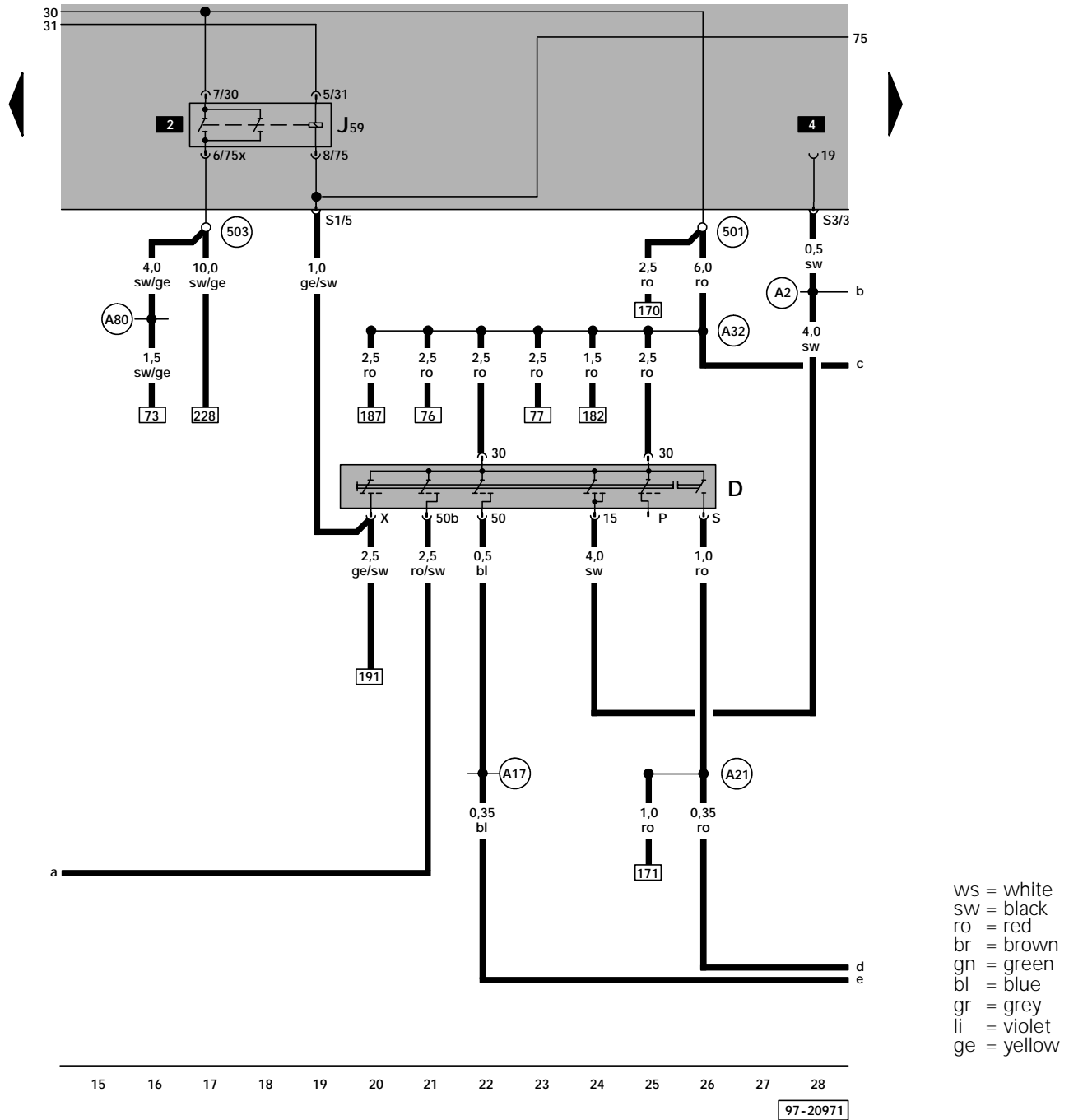

ws = white
 sw = black
 ro = red
 br = brown
 gn = green
 bl = blue
 gr = grey
 li = violet
 ge = yellow

- D - Ignition/Starter Switch
- J59 - Load Reduction Relay, production control number (213)
- (501) - Screw connection -2- (30), on relay panel
- (503) - Screw connection (75x), on relay panel
- (A2) - plus connection (15), in instrument panel wiring harness
- (A17) - wire connection (61), in instrument panel wiring harness
- (A21) - wire connection (86s), in instrument panel wiring harness
- (A32) - plus connection (30), in instrument panel wiring harness

(A80) - Connector -1- (X), in instrument panel wiring harness

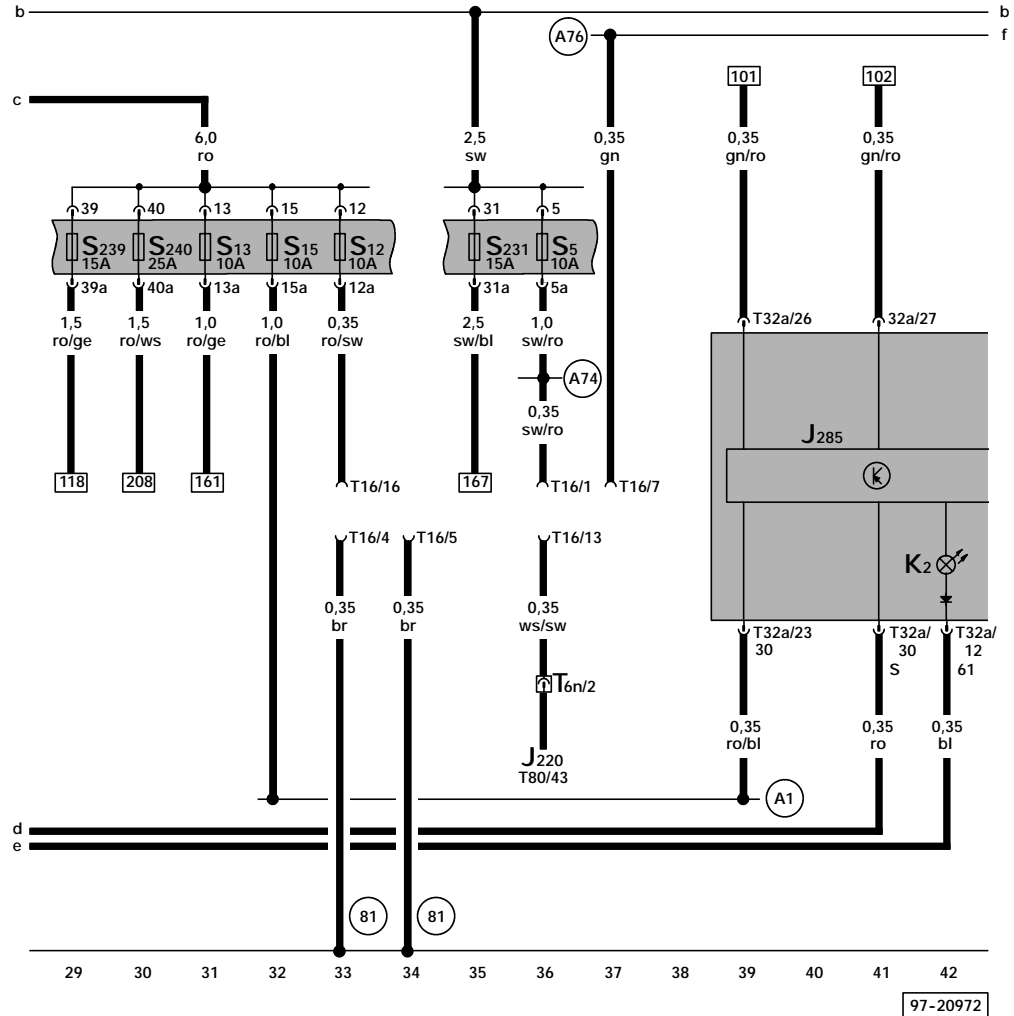
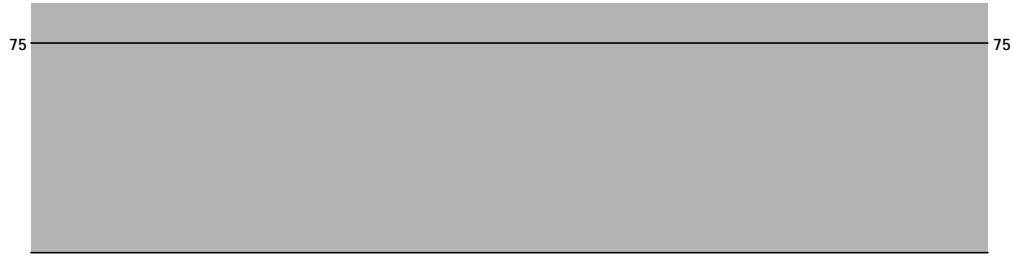

ws = white
 sw = black
 ro = red
 br = brown
 gn = green
 bl = blue
 gr = grey
 li = violet
 ge = yellow

- J220 - Motronic Engine Control Module (ECM)
- J285 - Control module with indicator unit in instrument panel insert
- K2 - Generator (GEN) Warning Light
- S5 - Fuse 5 in fuse holder
- S12 - Fuse 12 in fuse holder
- S13 - Fuse 13 in fuse holder
- S15 - Fuse 15 in fuse holder
- S231 - Fuse 31 in fuse holder
- S239 - Fuse 39 in fuse holder
- S240 - Fuse 40 in fuse holder
- T6n - 6-Pin Connector, red, on protective housing for control module, in engine compartment, left
- T16 - 16-Pin Connector, Data Link Connector (DLC), below instrument panel, left
- T32a - 32-Pin Connector, blue, on instrument cluster

- T80 - Connector, 80 point, on Engine Control Module (ECM)
- (81) - Ground connection -1-, in instrument panel wiring harness
- (A1) - plus connection (30a), in instrument panel wiring harness
- (A74) - Connector (15a - fuse 5), in instrument panel wiring harness
- (A76) - Connector (K-diagnosis wire), in instrument panel wiring harness

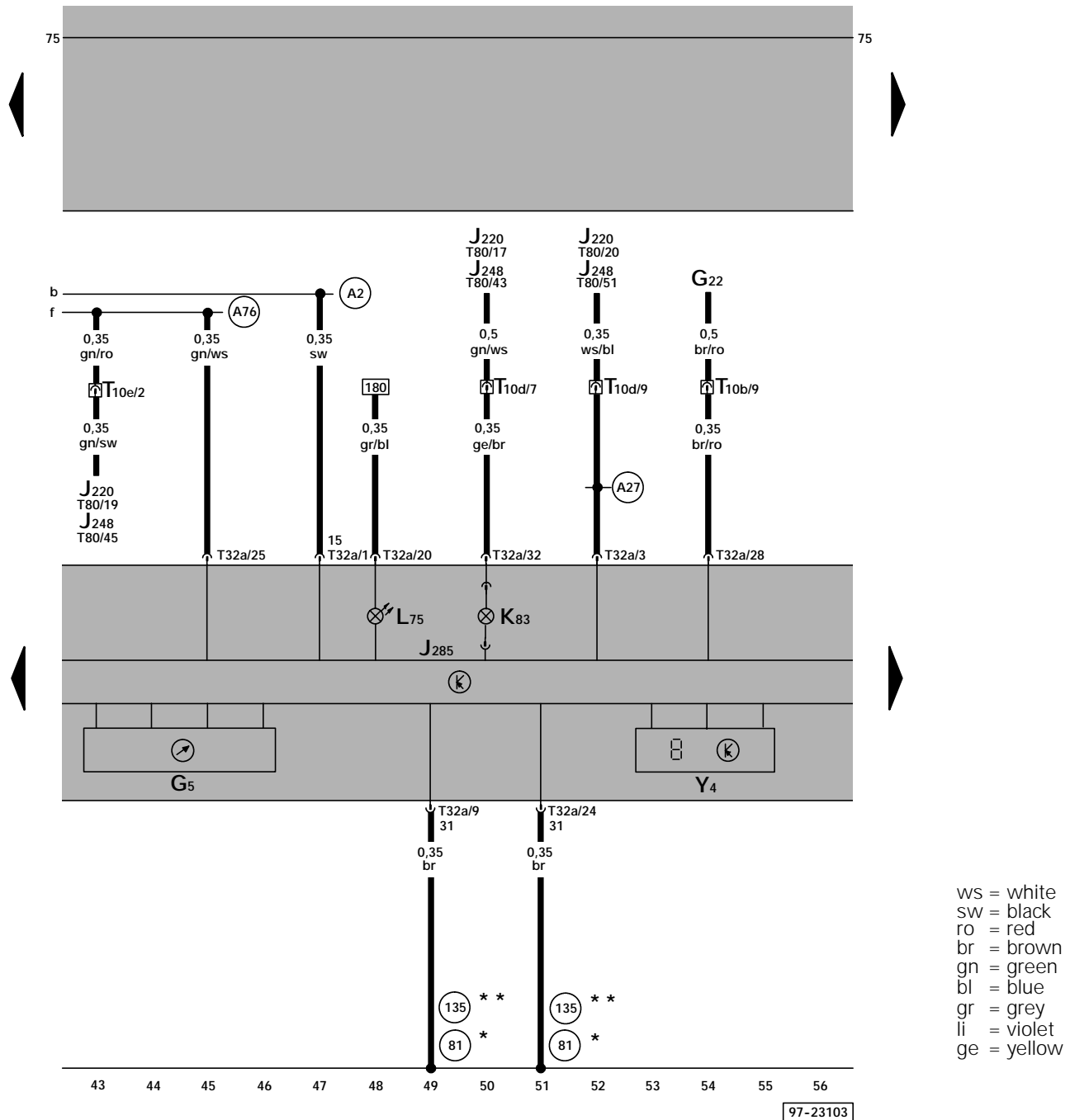

ws = white
 sw = black
 ro = red
 br = brown
 gn = green
 bl = blue
 gr = grey
 li = violet
 ge = yellow

- G5 - Tachometer
- J220 - Motronic Engine Control Module (ECM)
- J248 - Diesel Direct Fuel Injection (DFI) Engine Control Module (ECM)
- J285 - Control module with indicator unit in instrument panel insert
- K83 - Malfunction Indicator Lamp (MIL)
- L75 - Digital Display Light
- T10b - 10-Pin Connector, black, on protective housing for control module, in engine compartment, left
- T10d - 10-Pin Connector, brown, on protective housing for control module, in engine compartment, left
- T10e - 10-Pin Connector, yellow, on protective housing for control module, in engine compartment, left
- T32a - 32-Pin Connector, blue, on instrument cluster
- T80 - Connector, 80 point, on Engine Control Module (ECM)

- Y4 - Odometer Display
- (81) - Ground connection -1-, in instrument panel wiring harness
- (135) - Ground connection -2-, in instrument panel wiring harness
- (A2) - plus connection (15), in instrument panel wiring harness
- (A27) - Wire Connection (vehicle speed signal), in instrument panel wiring harness
- * - to April 1998
- ** - from May 1998

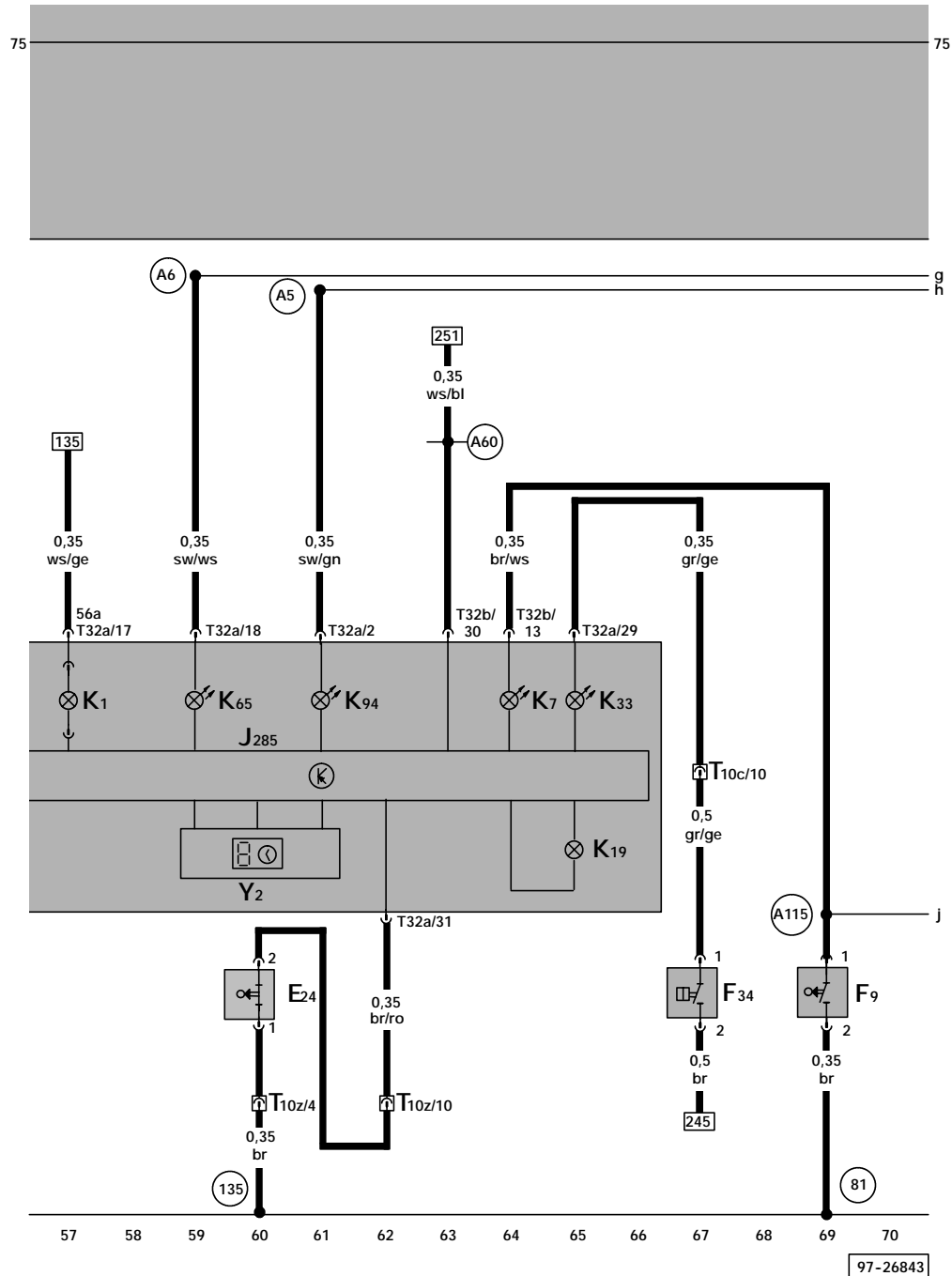

ws = white
 sw = black
 ro = red
 br = brown
 gn = green
 bl = blue
 gr = grey
 li = violet
 ge = yellow

- E24 - Left Seat Belt Switch
- F9 - Parking Brake Warning Light Switch
- F34 - Brake Fluid Level Warning Switch
- J285 - Control module with indicator unit in instrument panel insert
- K1 - Headlight High Beam Indicator Light
- K7 - Brake and Parking Brake Warning Light
- K19 - Seat Belt Warning Light
- K33 - Brake Fluid Level Warning Light
- K65 - Left Turn Signal Indicator Light
- K94 - Right Turn Signal Indicator Light
- T10c - 10-Pin Connector, violet, connector station A-pillar, left
- T10z - 10-Pin Connector, brown
- T32a - 32-Pin Connector, blue, on instrument cluster
- T32b - 32-Pin Connector, green, on instrument cluster

- Y2 - Digital Clock
- (81) - Ground connection -1-, in instrument panel wiring harness
- (135) - Ground connection -2-, in instrument panel wiring harness
- (A5) - plus connection (right turn signal), in instrument panel wiring harness
- (A6) - plus connection (left turn signal), in instrument panel wiring harness
- (A60) - Wire connection (Vehicle speed signal), in instrument cluster wiring harness
- (A115) - Connection (parking brake warning light), in instrument panel wiring harness

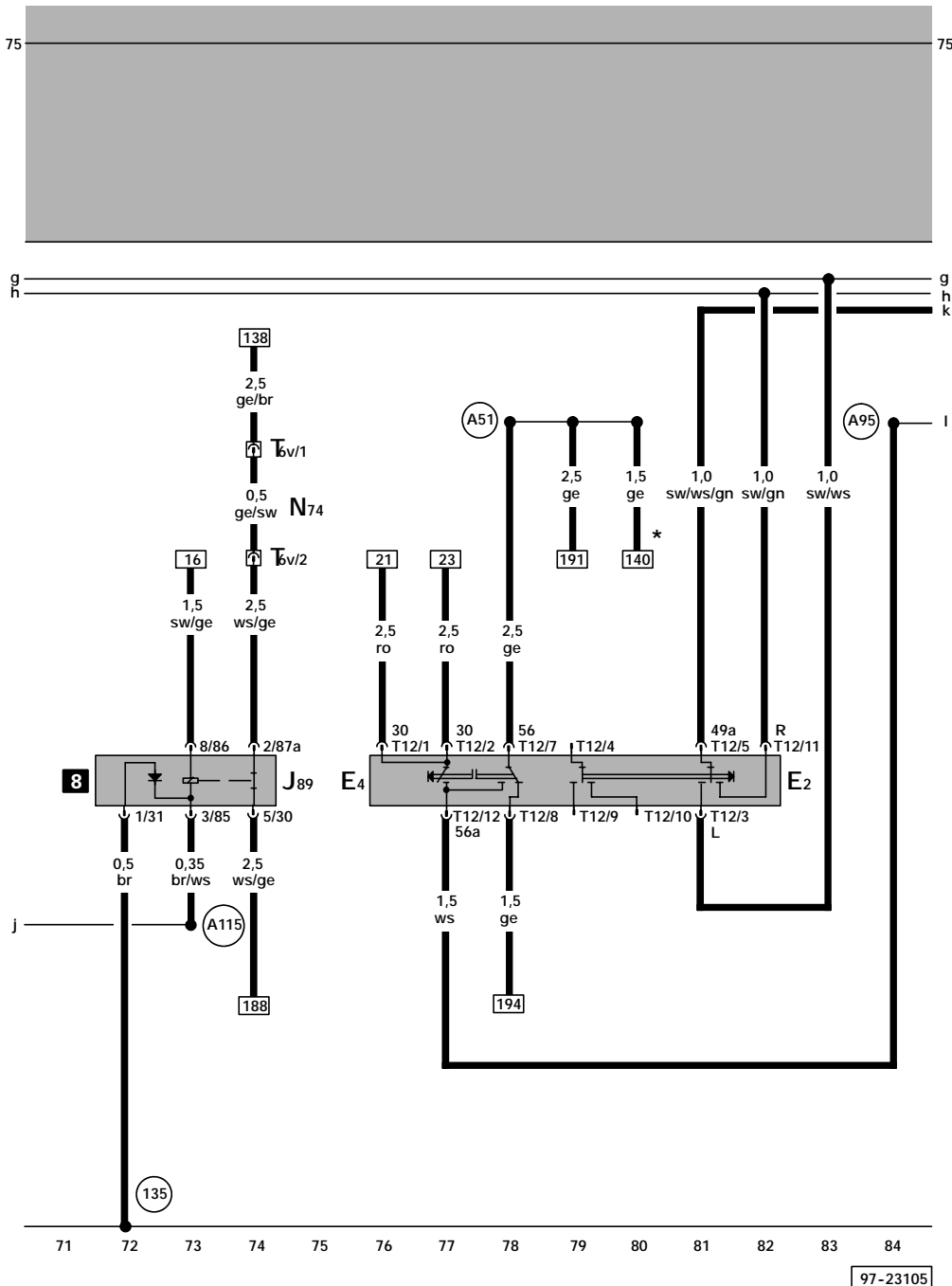

ws = white
 sw = black
 ro = red
 br = brown
 gn = green
 bl = blue
 gr = grey
 li = violet
 ge = yellow

- E2 - Turn Signal Switch
- E4 - Headlight Dimmer/Flasher Switch
- J89 - Daytime Running Lights Change-over Relay on the thirteenfold relay panel, above relay panel, production control number (173)
- N74 - Series Resistance Wiring
- T6v - 6-Pin Connector, violet, connector station A-pillar, right
- T12 - 12-Pin Connector, near steering column

(A115) - Connection (parking brake warning light), in instrument panel wiring harness

* - to May 1998

- (135) - Ground connection -2-, in instrument panel wiring harness
- (A51) - wire connection (56), in instrument panel wiring harness
- (A95) - wire connection -1- (56a), in instrument panel wiring harness

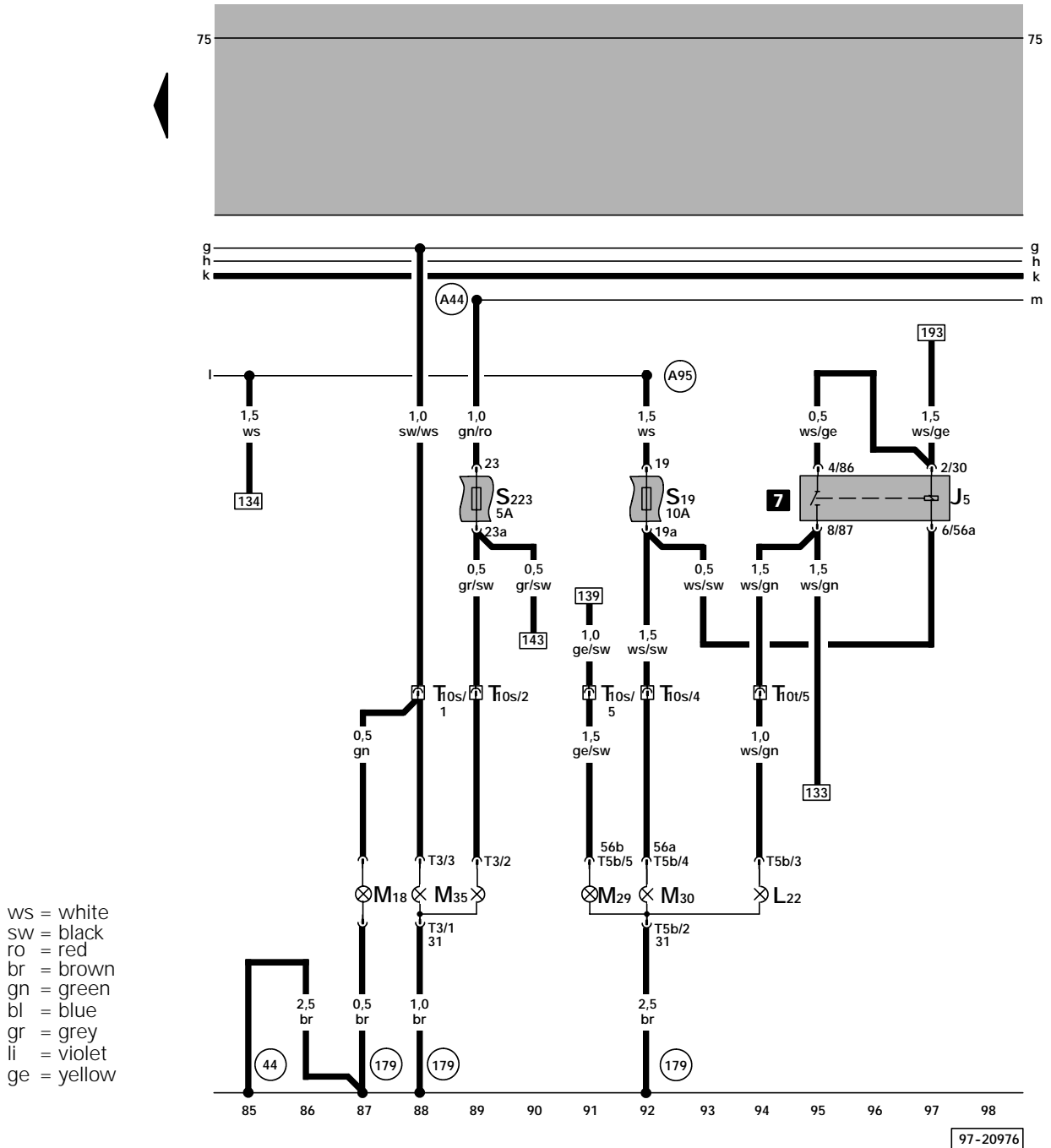

- J5 - Fog Light Relay, on auxiliary relay panel, production control number (381)
- L22 - Left Front Fog Light
- M18 - Left, Side Turn Signal Light
- M29 - Left Low Beam Headlight
- M30 - Left High Beam Headlight
- M35 - Light for turn signal and side marker, front, left
- S19 - Fuse 19 in fuse holder
- S223 - Fuse 23 in fuse holder
- T3 - 3-Pin Connector
- T5b - 5-Pin Connector, on headlight left
- T10s - 10-Pin Connector, pink, connector station A-pillar, left
- T10t - 10-Pin Connector, red, connector station A-pillar, left

- (44) - Ground connection, on left A-pillar, lower part
- (179) - Ground connection, in left headlight wiring harness
- (A44) - wire connection (57r), in instrument panel wiring harness
- (A95) - Connection 1 (56a), in instrument panel wiring harness

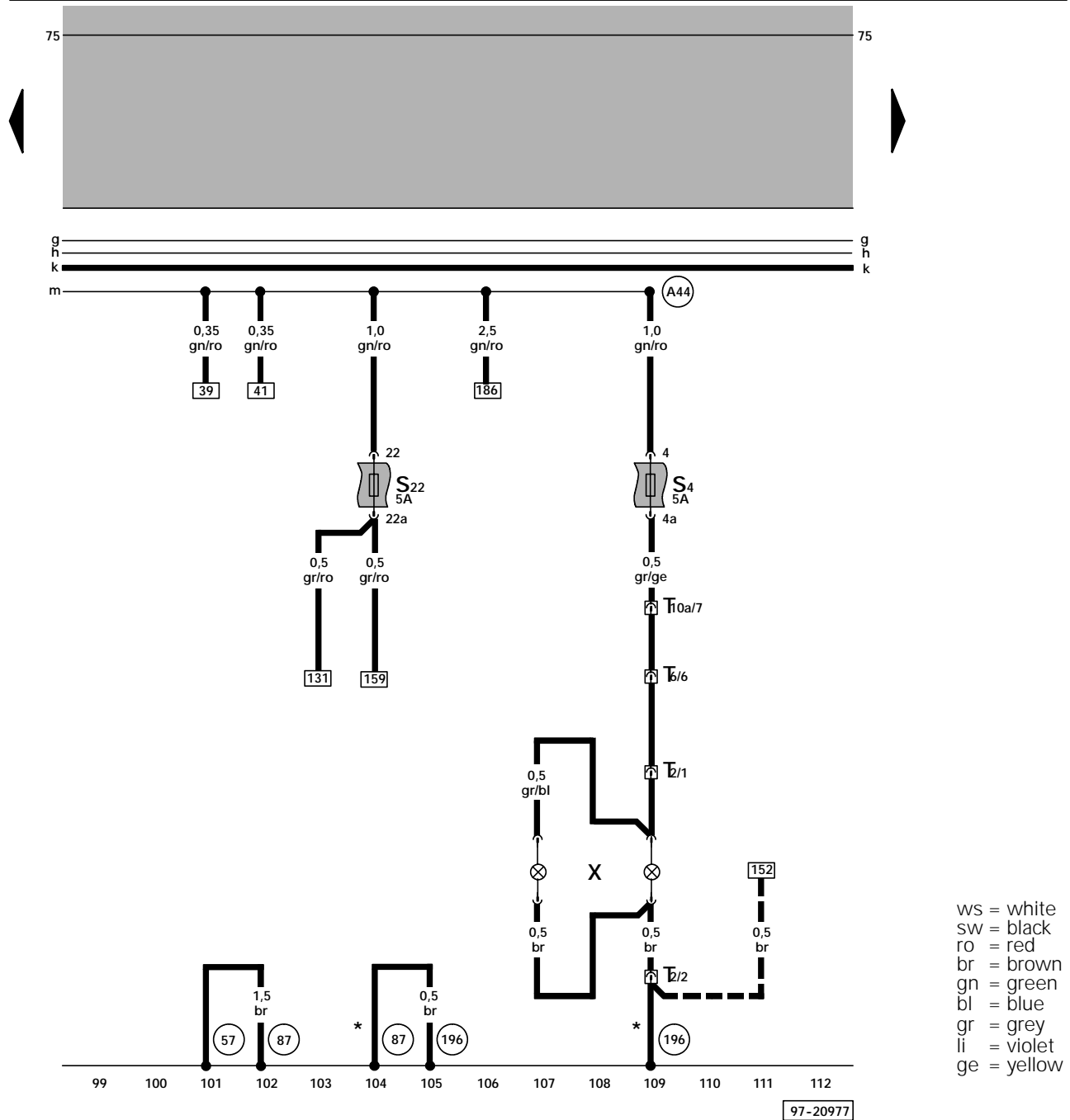

ws = white
 sw = black
 ro = red
 br = brown
 gn = green
 bl = blue
 gr = grey
 li = violet
 ge = yellow

- S4 - Fuse 4 in fuse holder
 - S22 - Fuse 22 in fuse holder
 - T2 - Double Connector, in rear lid
 - T6 - 6-Pin Connector, black, in luggage compartment, left (wagon only)
 - T10a - 10-Pin Connector, brown, connector station A-pillar, left
 - X - License Plate Lights
 - (57) - Ground connection, on left rear pillar
 - (87) - Ground connection -2-, in rear wiring harness
 - (196) - Ground connection -3-, in wiring harness, rear
 - (A44) - wire connection (57r), in instrument panel wiring harness
- wagon only
 * - sedan only

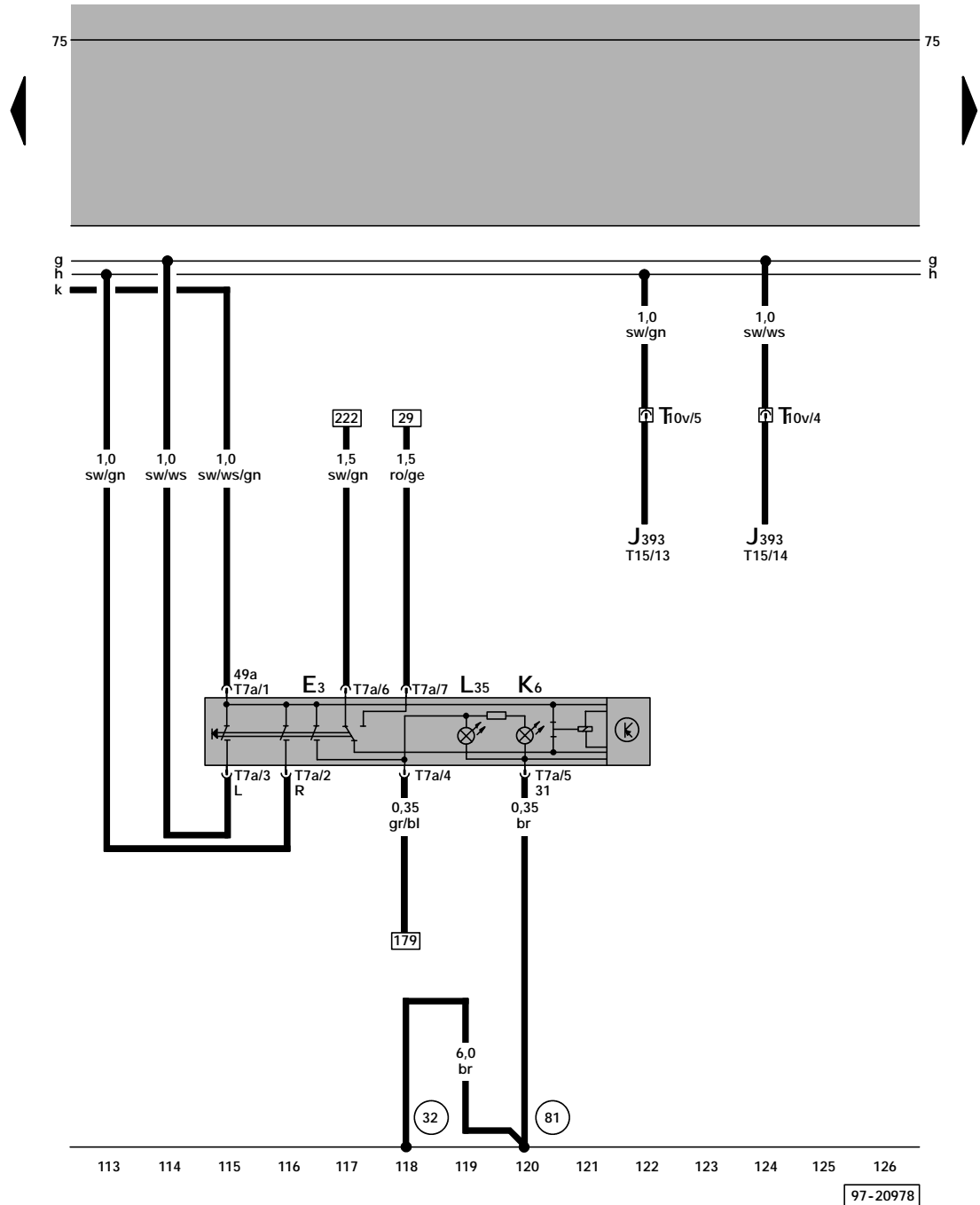

ws = white
 sw = black
 ro = red
 br = brown
 gn = green
 bl = blue
 gr = grey
 li = violet
 ge = yellow

- E3 - Emergency Flasher Switch
- J393 - Central control module for comfort system
- K6 - Emergency Flasher Warning Light
- L35 - Emergency Flasher Switch Light
- T7a - 7-Pin Connector, on emergency flasher switch
- T10v - 10-Pin Connector, violet, connector station A-pillar, right
- T15 - 15-Pin Connector, on central control module for comfort system
- 32 - Ground connection, behind instrument panel, left
- 81 - Ground connection -1-, in instrument panel wiring harness

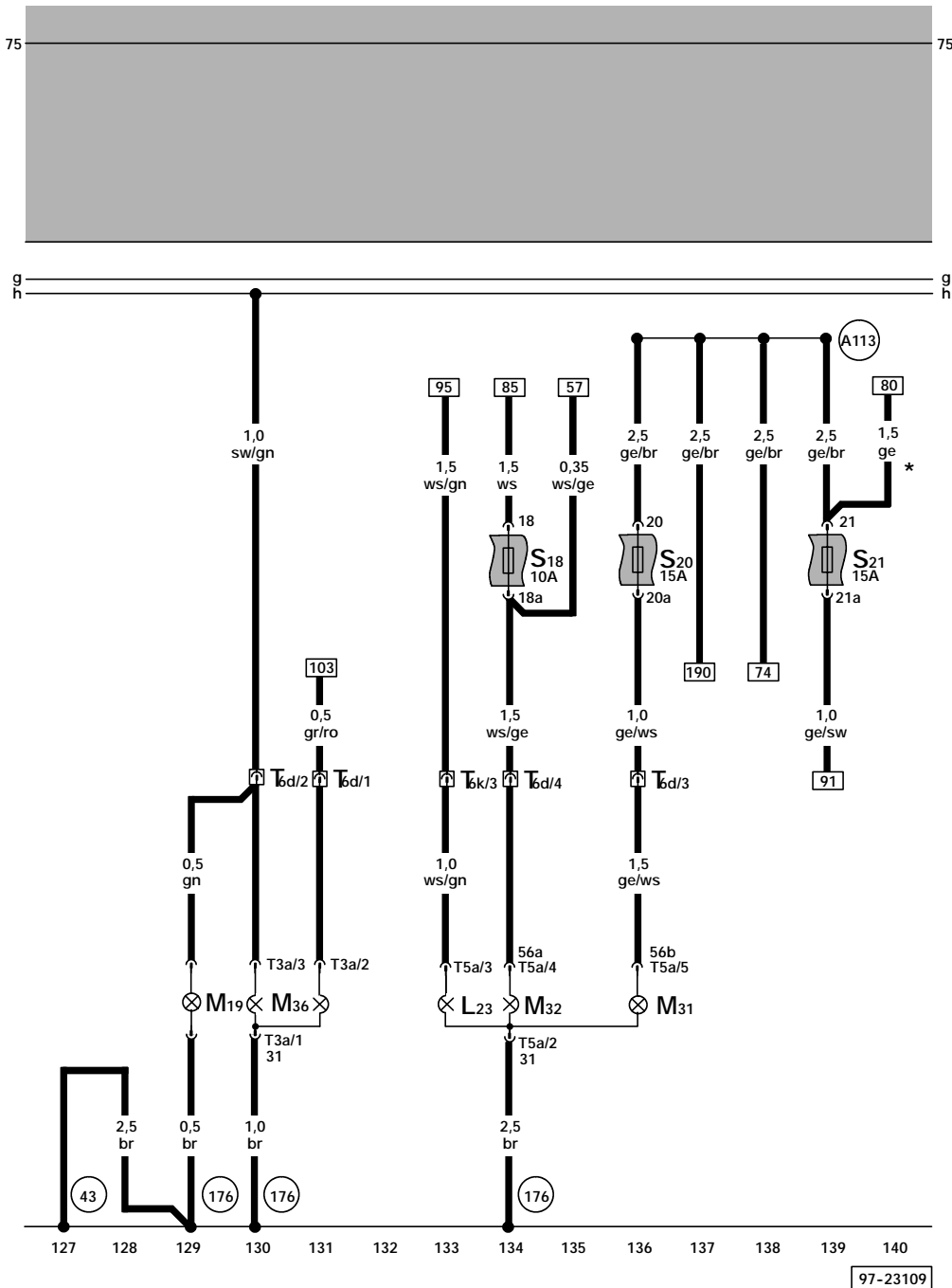

ws = white
 sw = black
 ro = red
 br = brown
 gn = green
 bl = blue
 gr = grey
 li = violet
 ge = yellow

- L23 - Right Front Fog Light
- M19 - Right, Side Turn Signal Light
- M31 - Right Low Beam Headlight
- M32 - Right High Beam Headlight
- M36 - Light for turn signal and side marker, front, right
- S18 - Fuse 18 in fuse holder
- S20 - Fuse 20 in fuse holder
- S21 - Fuse 21 in fuse holder
- T3a - 3-Pin Connector
- T5a - 5-Pin Connector, on headlight right
- T6d - 6-Pin Connector, yellow, connector station A-pillar, right
- T6k - 6-Pin Connector, red, connector station A-pillar, right

- (43) - Ground connection, on right A-pillar, lower part
- (176) - Ground connection, in right headlight wiring harness
- (A113) - Connection -2- (daytime running lights), in instrument panel wiring harness

* - to May 1998

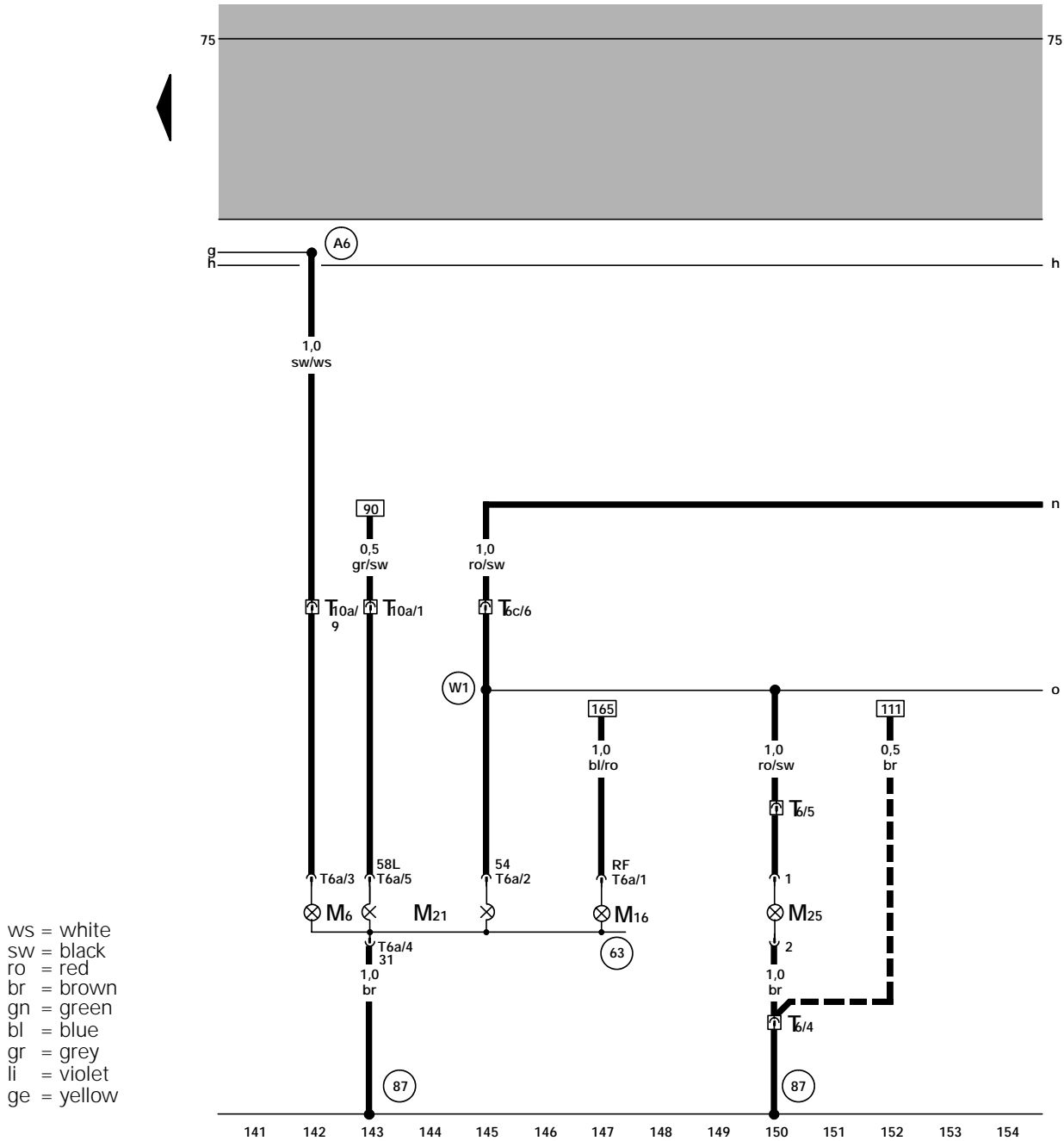

ws = white
 sw = black
 ro = red
 br = brown
 gn = green
 bl = blue
 gr = grey
 li = violet
 ge = yellow

- M6 - Left Rear Turn Signal Light
- M21 - Left Brake/Tail Light
- M16 - Left Back-Up Light
- M25 - High-mount Brake Light
- T6 - 6-Pin Connector, black, in luggage compartment, left (wagon only)
- T6a - 6-Pin Connector, on tail light, left
- T6c - 6-Pin Connector, blue, connector station A-pillar, left
- T10a - 10-Pin Connector, brown, connector station A-pillar, left
- (63) - Ground connection, on left taillight bulb holder
- (87) - Ground connection -2-, in rear wiring harness

- (A6) - plus connection (left turn signal), in instrument panel wiring harness
- (W1) - plus connection (54), in rear wiring harness
- - - wagon only

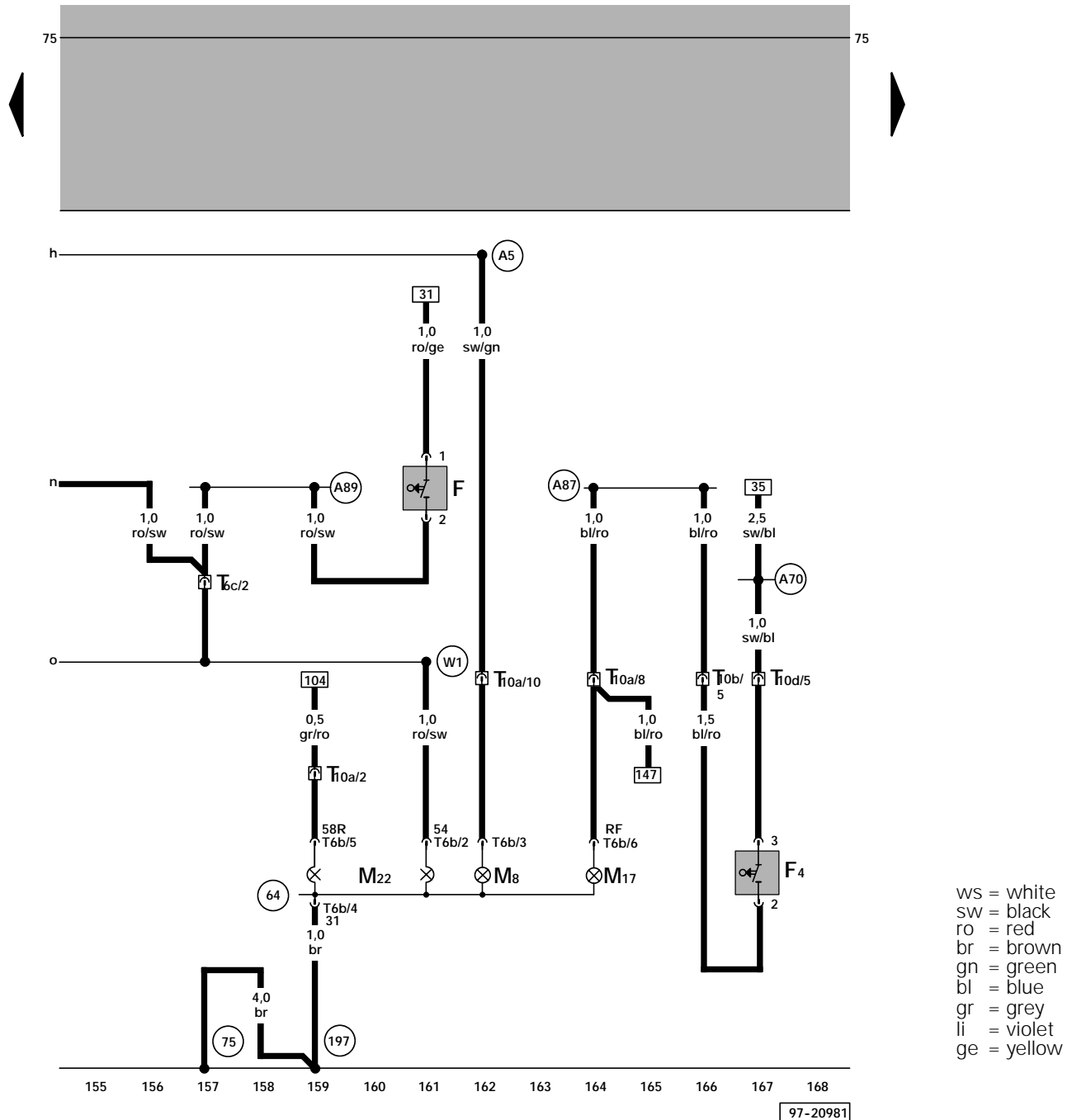

- F - Brake Light Switch
- F4 - Back-Up Light Switch
- M8 - Right Rear Turn Signal Light
- M17 - Right Back-Up Light
- M22 - Right Brake/Tail Light
- T6b - 6-Pin Connector, on tail light, right
- T6c - 6-Pin Connector, blue, connector station A-pillar, left
- T10a - 10-Pin Connector, brown, connector station A-pillar, left
- T10b - 10-Pin Connector, black, on protective housing for control module, in engine compartment, left
- T10d - 10-Pin Connector, brown, on protective housing for control module, in engine compartment, left
- (75) - Ground connection, on right rear pillar
- (197) - Ground connection -4-, in wiring harness rear
- (A5) - plus connection (right turn signal), in instrument panel wiring harness
- (A70) - Connector (15a, fuse 231), in instrument panel wiring harness
- (A87) - Connector (reverse lamp), in instrument panel wiring harness
- (A89) - Connector (54), in instrument panel wiring harness
- (W1) - plus connection (54), in rear wiring harness
- (64) - Ground connection, on right taillight bulb holder

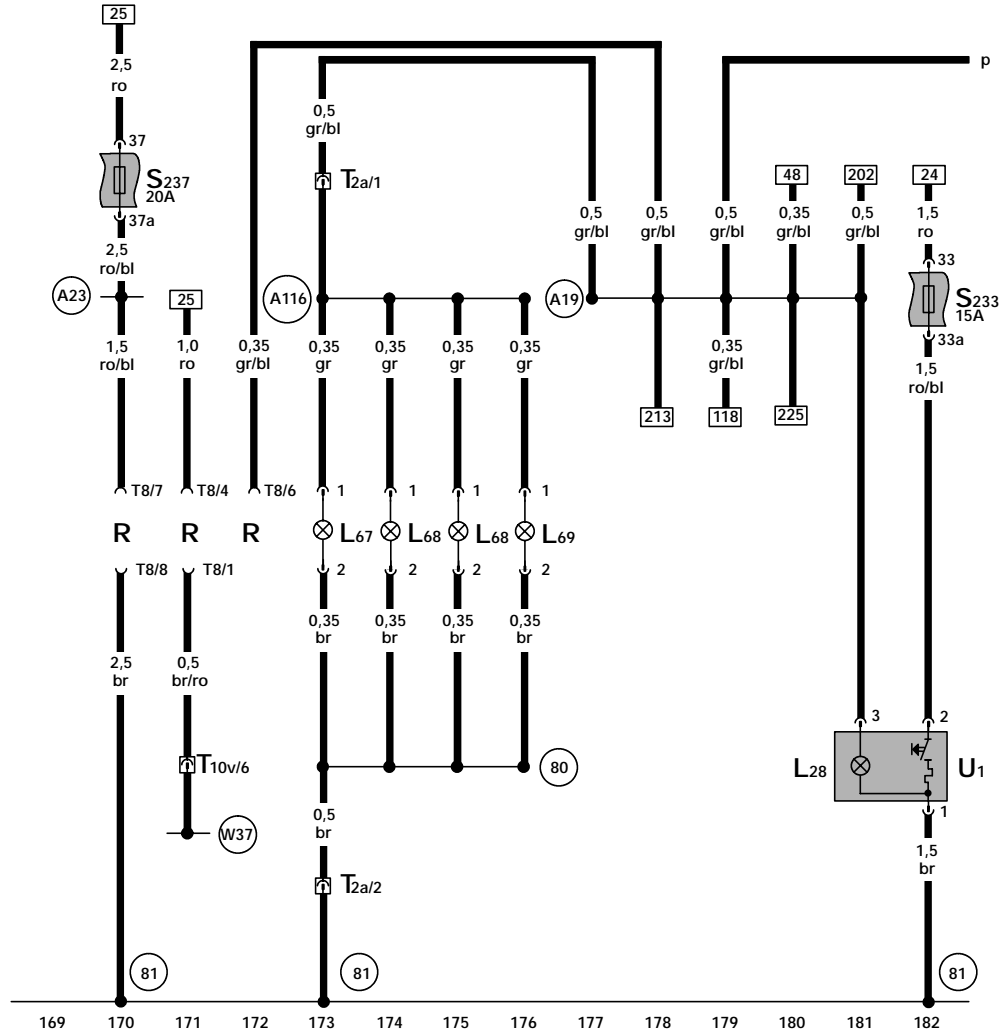
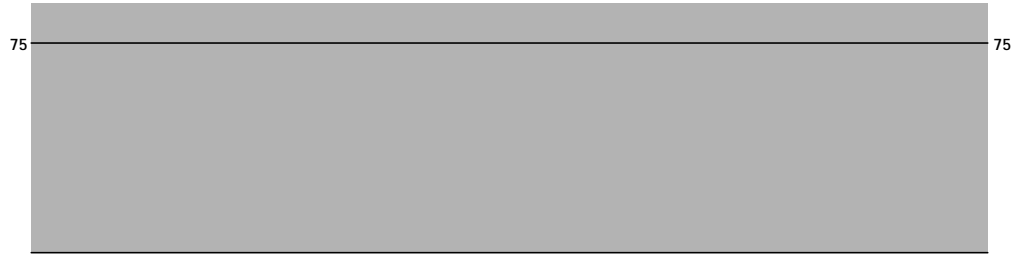

ws = white
 sw = black
 ro = red
 br = brown
 gn = green
 bl = blue
 gr = grey
 li = violet
 ge = yellow

- L28 - Cigarette Lighter Light
- L67 - Left Instrument Panel Vent Illumination
- L68 - Center Instrument Panel Vent Illumination
- L69 - Right Instrument Panel Vent Illumination
- R - Radio
- S233 - Fuse 33 in fuse holder
- S237 - Fuse 37 in fuse holder
- T2a - Double Connector
- T6n - 6-Pin Connector, red, on protective housing for control module, in engine compartment, left
- T8 - 8-Pin Connector, on radio
- T10v - 10-Pin Connector, violet, connector station A-pillar, right
- U1 - Cigarette Lighter

- (81) - Ground connection -1-, in instrument panel wiring harness
- (A19) - wire connection (58d), in instrument panel wiring harness
- (A23) - wire connection (30a), in instrument panel wiring harness
- (A116) - wire connection -2- (58d), in instrument panel wiring harness
- (W37) - Connector (alarm system), in wiring harness floor

- (80) - Ground connection -1-, in instrument panel wiring harness

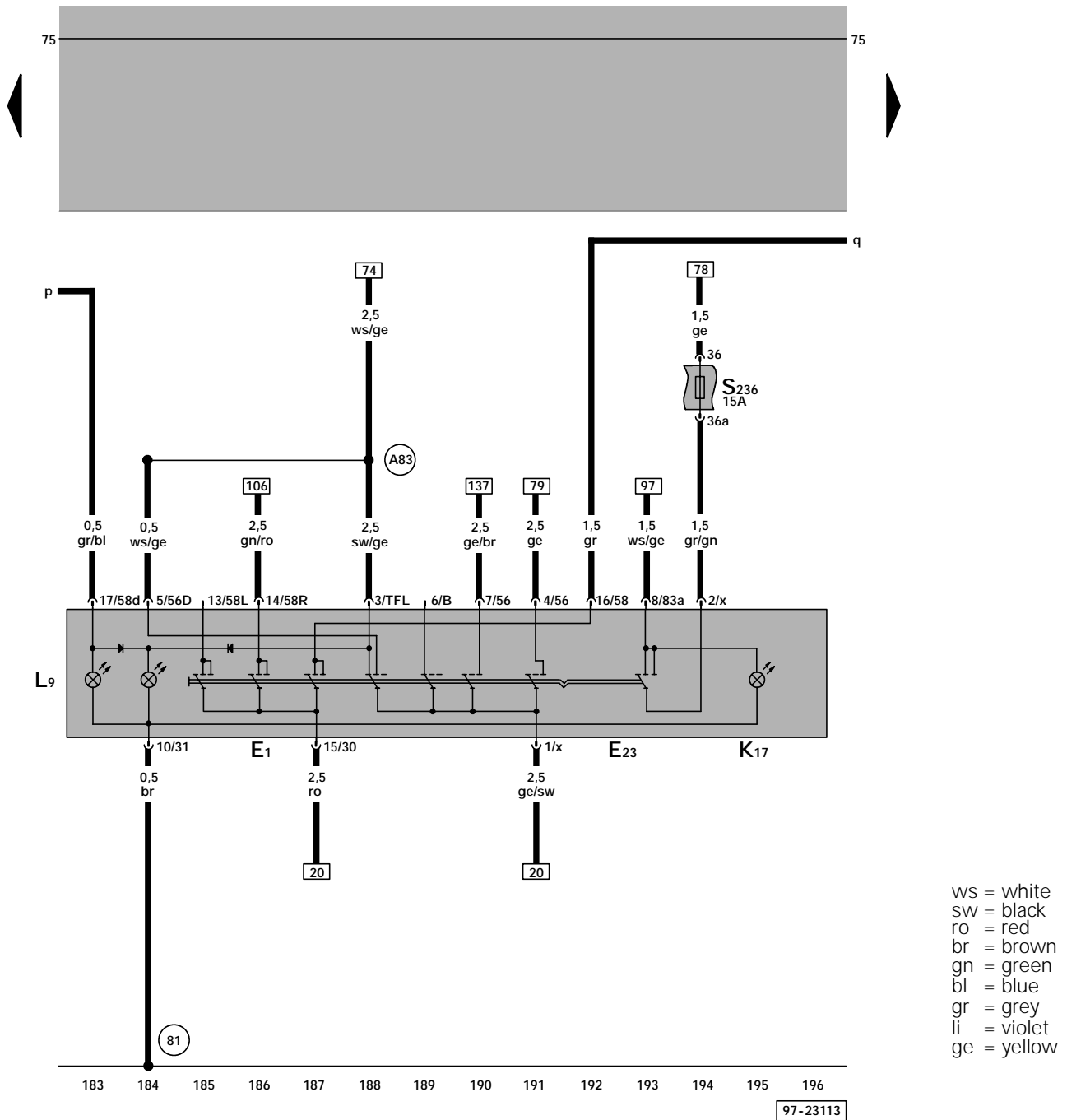

ws = white
 sw = black
 ro = red
 br = brown
 gn = green
 bl = blue
 gr = grey
 li = violet
 ge = yellow

- E1 - Light switch
- E23 - Fog Light Switch
- K17 - Fog Light Indicator Light
- L9 - Headlight Switch Licht
- S236 - Fuse 36 in fuse holder

- (81) - Ground connection -1-, in instrument panel wiring harness
- (A83) - Connector (daytime running lights), in instrument panel wiring harness

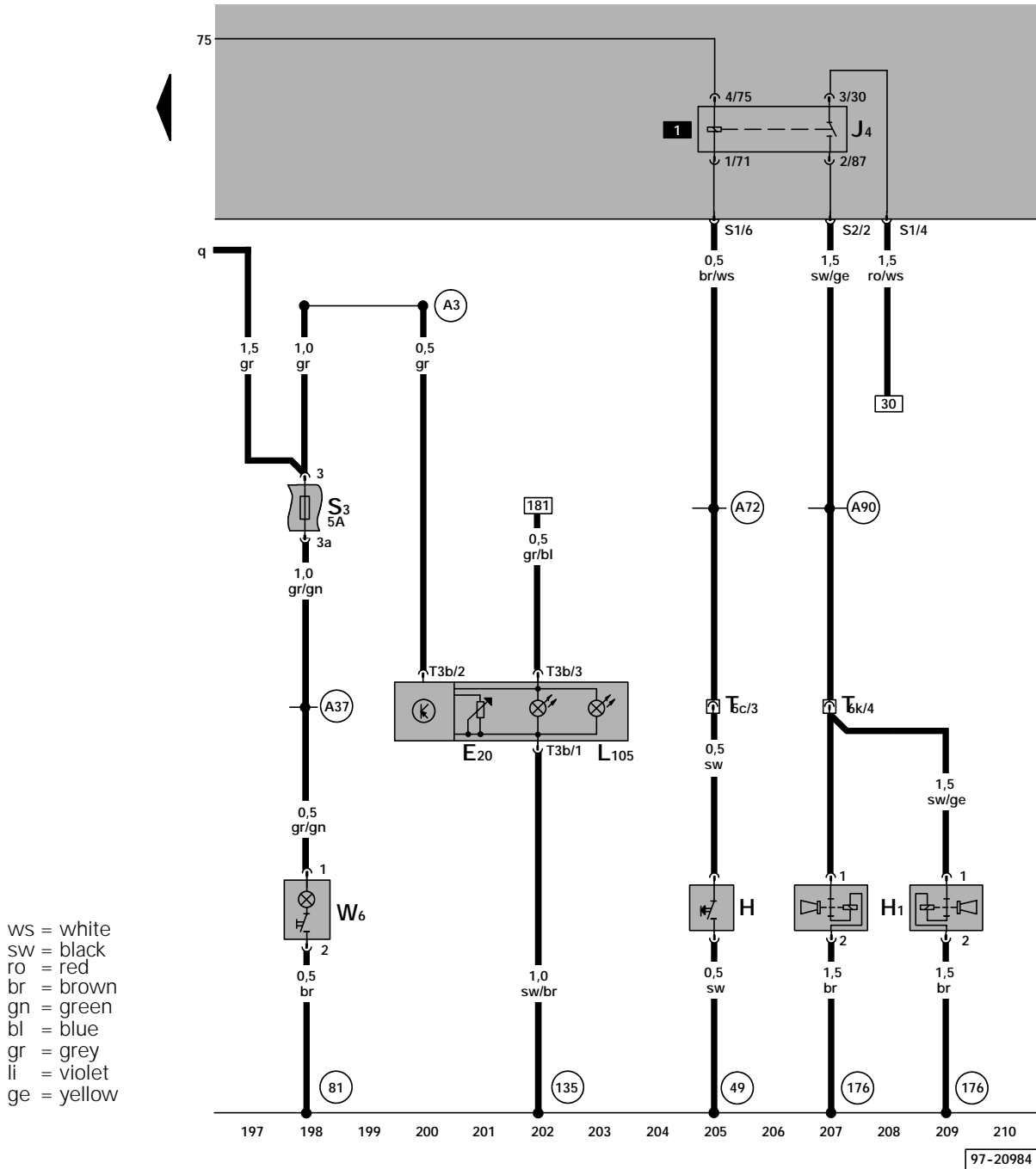

ws = white
 sw = black
 ro = red
 br = brown
 gn = green
 bl = blue
 gr = grey
 li = violet
 ge = yellow

- E20 - Instrument Panel Light Dimmer Switch
- H - Horn Button
- H1 - Dual Horns
- J4 - Dual Horn Relay, production control number (204)
- L105 - Illumination for Instrument Panel Light Dimmer Switch
- S3 - Fuse 3 in fuse holder
- T3b - 3-Pin Connector
- T5c - 5-Pin Connector, yellow, near steering column
- T6k - 6-Pin Connector, red, connector station A-pillar, right
- W6 - Glove Compartment Light

- (81) - Ground connection -1-, in instrument panel wiring harness
- (135) - Ground connection -2-, in instrument panel wiring harness
- (176) - Ground connection, in right headlight wiring harness
- (A3) - plusconnection (58), in instrument panel wiring harness
- (A37) - wire connection (58a), in instrument panel wiring harness
- (A72) - Connector (71), in instrument panel wiring harness
- (A90) - Connector (two-tone horn), in instrument panel wiring harness

- (49) - Ground connection, near steering wheel

97-20984

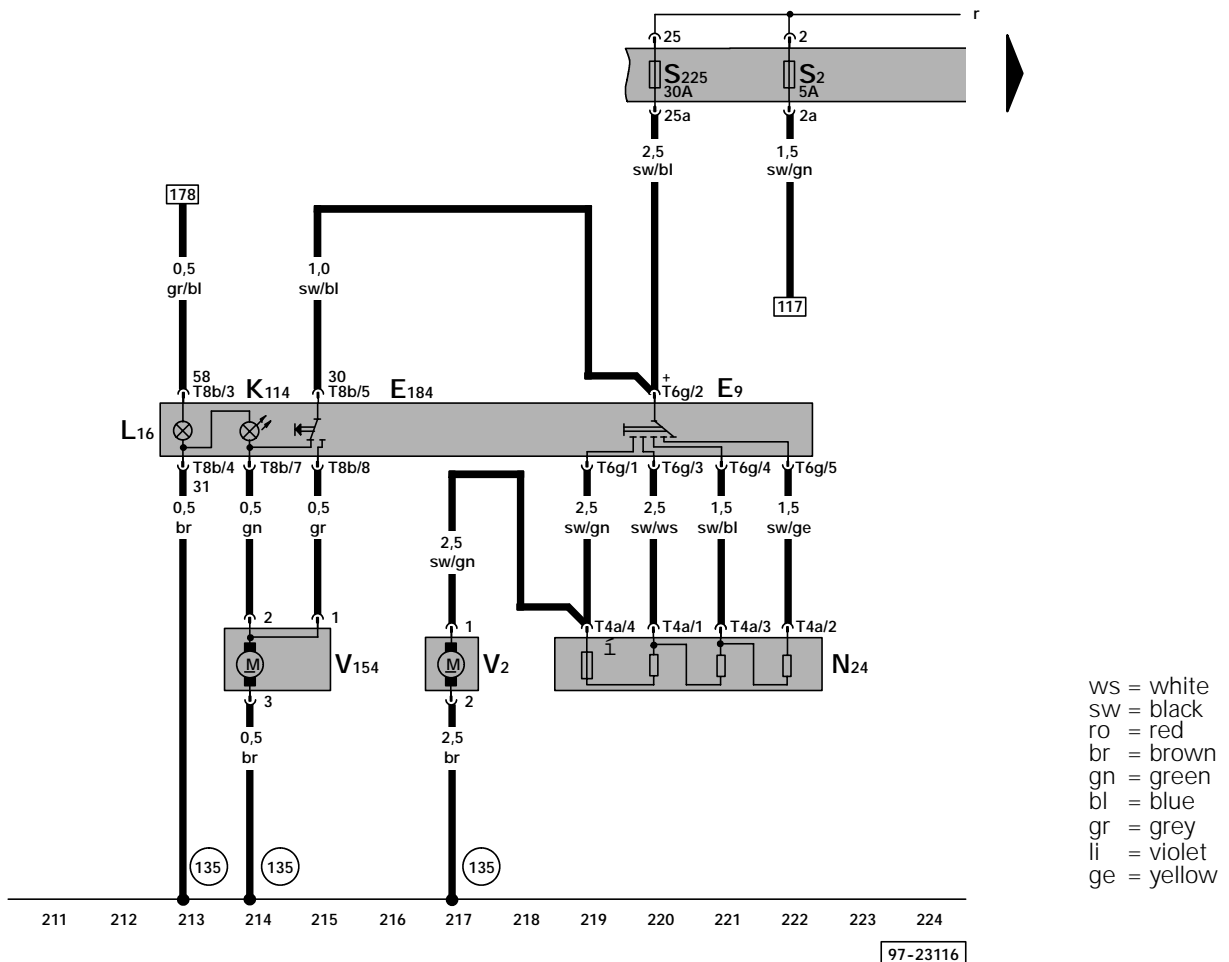

- E9 - Fresh Air Blower Switch
- E184 - Switch for fresh air blower and recirculated air
- K114 - Fresh Air and Recirculating Air Mode Indicator Light
- L16 - Fresh Air Control Lever Light
- N24 - Fresh Air Blower Series Resistance With Fuse
- S2 - Fuse 2 in fuse holder
- S225 - Fuse 25 in fuse holder
- T4a - 4-Pin Connector
- T6g - 6-Pin Connector, on fresh air blower switch
- T8b - 8-Pin Connector, on switch for fresh air blower and recirculated air
- V2 - Fresh Air Blower
- V154 - Servo motor for fresh-/recirculating air door
- 135 - Ground connection -2-, in instrument panel wiring harness

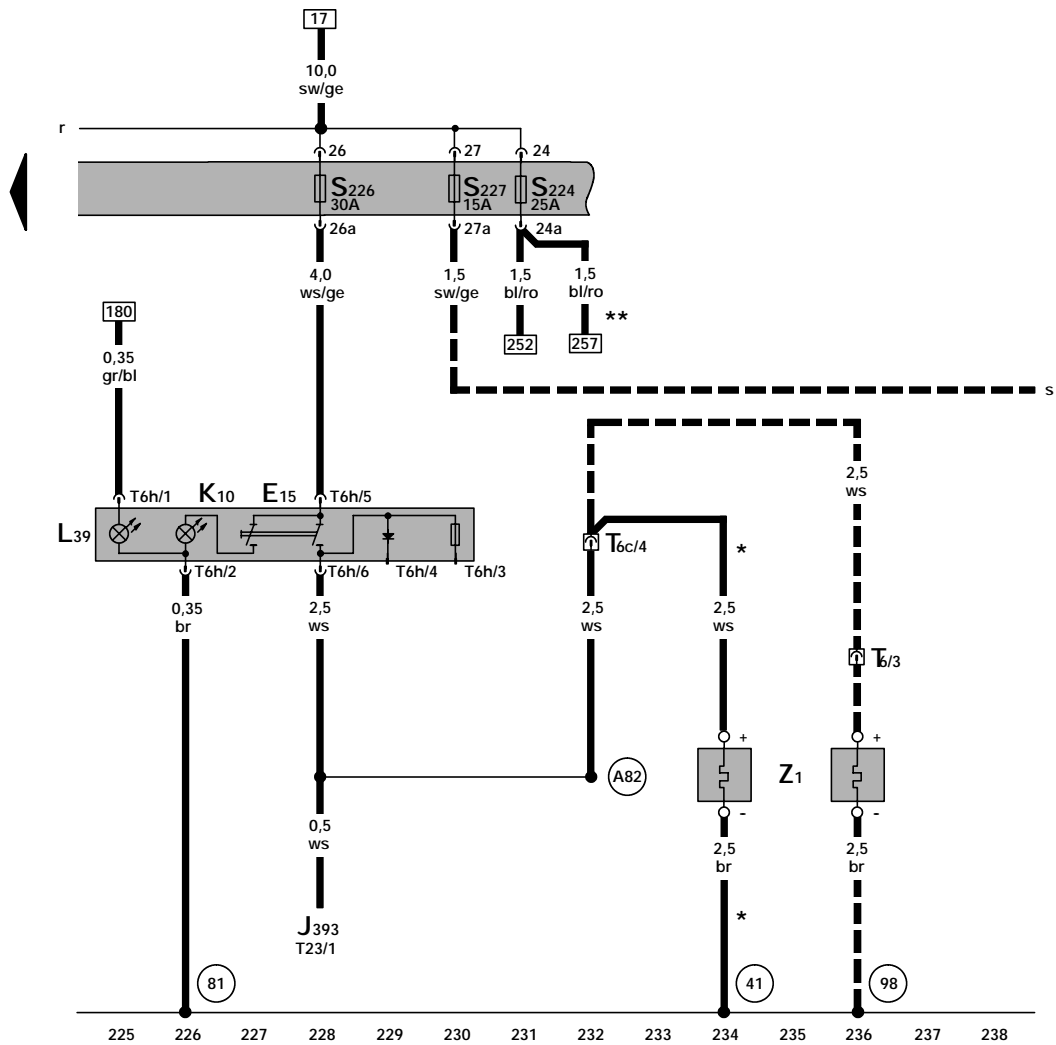

ws = white
 sw = black
 ro = red
 br = brown
 gn = green
 bl = blue
 gr = grey
 li = violet
 ge = yellow

97-23117

- E15 - Rear window defogger switch
- J393 - Central control module for comfort system
- K10 - Rear Window Defogger Indicator Light
- L39 - Rear Window Defogger Switch Light
- S224 - Fuse 24 in fuse holder
- S226 - Fuse 26 in fuse holder
- S227 - Fuse 27 in fuse holder
- T6 - 6-Pin Connector, black, in luggage compartment, left (wagon only)
- T6c - 6-Pin Connector, blue, connector station A-pillar, left
- T6h - 6-Pin Connector, black, on rear window defogger switch
- T23 - 23-Pin Connector, on central control module for comfort system
- Z1 - Heated rear window
- (41) - Ground connection, below rear shelf
- (81) - Ground connection -1-, in instrument panel wiring harness
- (98) - Ground connection, in rear lid wiring harness
- (A82) - Connector (heated glass), in instrument panel wiring harness
- - - - wagon only
- * - sedan only
- ** - to May 1998

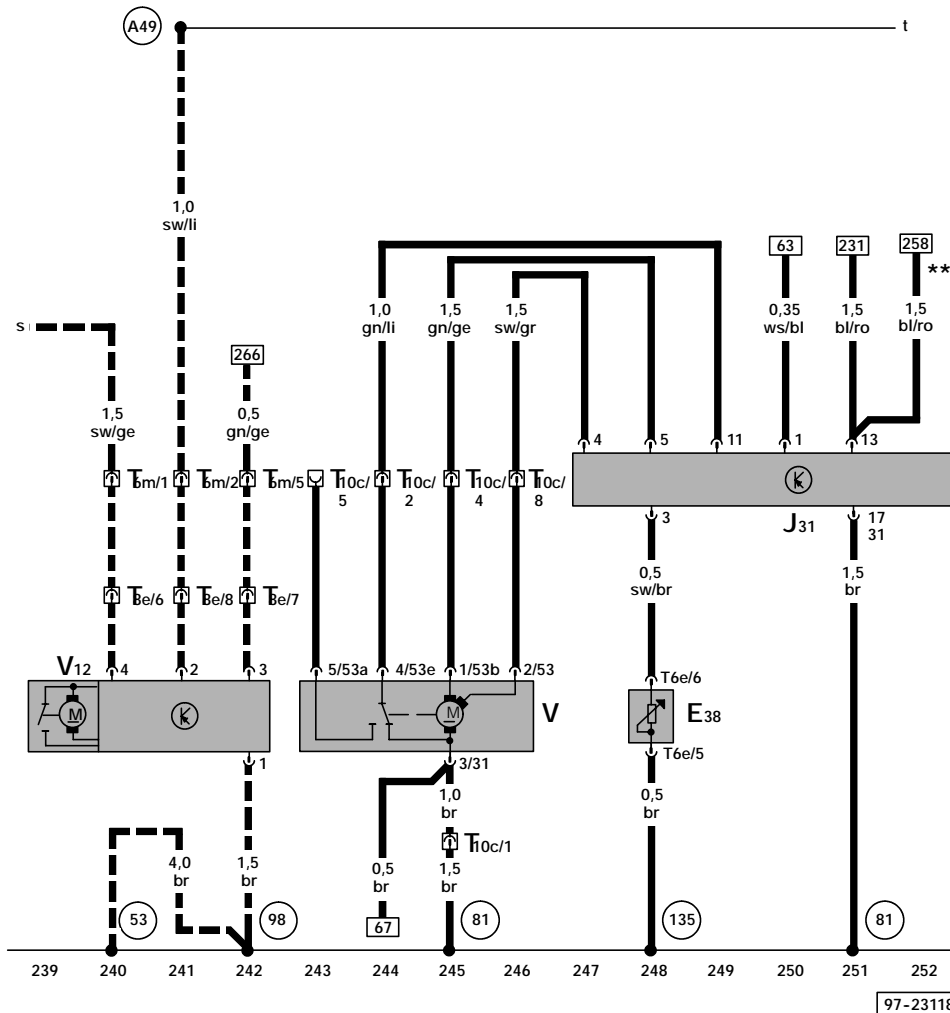

ws = white
 sw = black
 ro = red
 br = brown
 gn = green
 bl = blue
 gr = grey
 li = violet
 ge = yellow

- E38 - Windshield Wiper Intermittent Regulator
- J31 - Wiper/Washer Intermittent Relay, production control number (377)
- T6e - 6-Pin Connector, black, behind steering column switch cover
- T6m - 6-Pin Connector, black, connector station A-pillar, right
- T8e - 8-Pin Connector, black, in rear lid, right
- T10c - 10-Pin Connector, violet, connector station A-pillar, left
- V - Windshield Wiper Motor
- V12 - Rear Window Wiper Motor

- (98) - Ground connection, in rear lid wiring harness
- (135) - Ground connection -2-, in instrument panel wiring harness
- (A49) - wire connection -1-, in instrument panel wiring harness
- - - wagon only
- ** from May 1998

- (53) - Ground connection, in rear lid, right
- (81) - Ground connection -1-, in instrument panel wiring harness

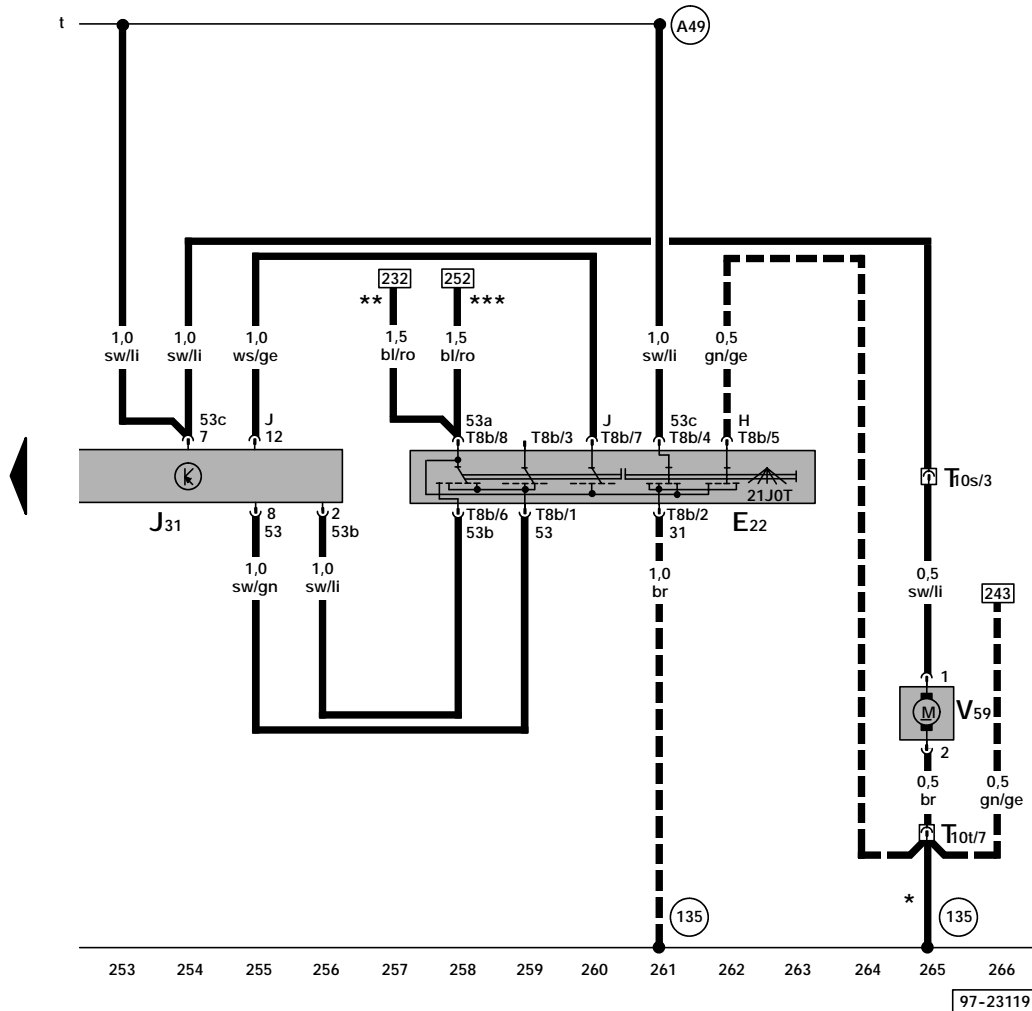

ws = white
 sw = black
 ro = red
 br = brown
 gn = green
 bl = blue
 gr = grey
 li = violet
 ge = yellow

- E22 - Windshield Wiper/Washer Switch
- J31 - Wiper/Washer Intermittent Relay, production control number (377)
- T8b - 8-Pin Connector, on Windshield Wiper/Washer Switch
- T10s - 10-Pin Connector, pink, connector station A-pillar, left
- T10t - 10-Pin Connector, red, connector station A-pillar, left
- V59 - Windshield and Rear Window Washer Pump
- (135) - Ground connection -2-, in instrument panel wiring harness
- (A49) - wire connection -1-, in instrument panel wiring harness
- - - wagon only
- * - sedan only
- ** - to May 1998
- *** - from May 1998